

SPRINGER®



TAYLOR 1200

Powerful and durable

TAYLOR 1200

Powerful and durable



SPRINGER's TAYLOR 1200 butt-end reducer increases productivity in the sawmill right at the start of the production process. The system can be integrated as a bypass solution or directly at the log infeed.

The TAYLOR 1200 extends the log infeed without delaying the production flow. Within a very short time, it can be integrated into

existing log infeeds without an additional base frame.

Thanks to angled cutting shafts, an optimal contour-oriented reduction is possible. Chainless conveyor units and Hardox toothed wheels characterize the maintenance-friendly and durable butt-end reducer TAYLOR 1200.

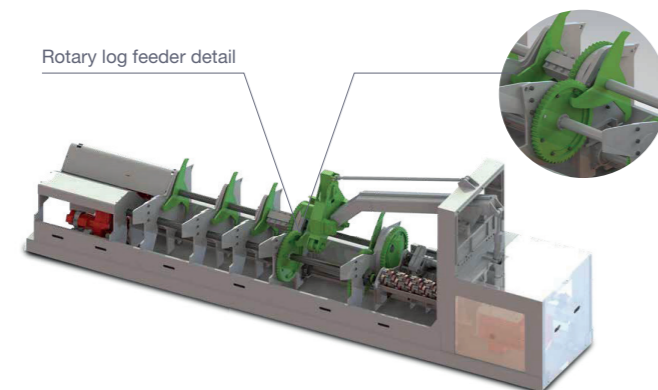

Rotary log feeder detail

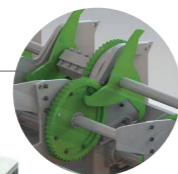

TAYLOR 1200 with rotary log feeder

Reduction capacity at \varnothing 400mm:	8 sec
Log length (standard):	3,0 – 7,3 m
Log diameter:	150 - 900mm
Length of reduction:	ca. 1000 mm
Milling shaft length:	1236 mm
Logs in cross transport without reduction:	45 logs/min

TAYLOR 1200 - LONG with lift-out mechanism

Reduction capacity at \varnothing 400mm:	8 sec
Log length (standard):	3,0 – 22,0 m
Log diameter:	150 - 900 mm
Length of reduction:	ca.1000 mm
Milling shaft length:	1236 mm
Logs in cross transport without reduction:	up to 25 logs/min

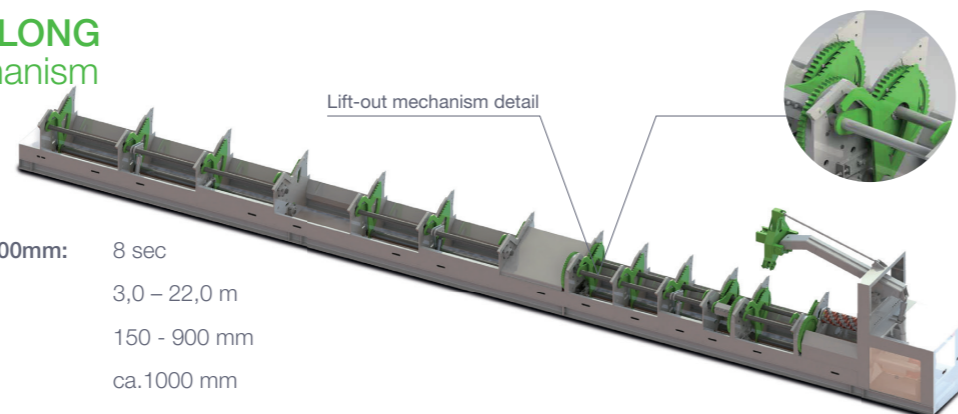

Lift-out mechanism detail

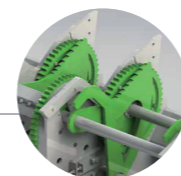

TAYLOR 1200 - DUO double reducer

Reduction capacity at \varnothing 400mm:	8 sec
Log length (standard):	3,0 – 7,3 m
Log diameter:	150 - 900mm
Length of reduction:	ca.1000 mm
Milling shaft length:	1236 mm
Logs in cross transport without reduction:	25 logs/min

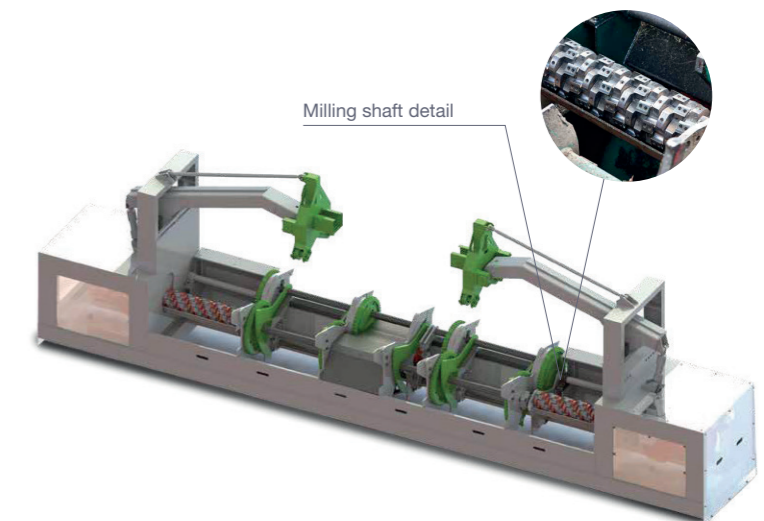

Milling shaft detail



TAYLOR 1200 - SPECIAL Sondermodelle

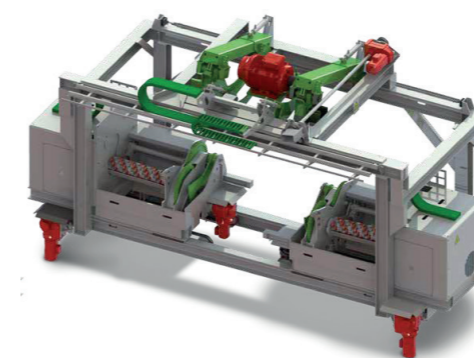

Gentle log handling

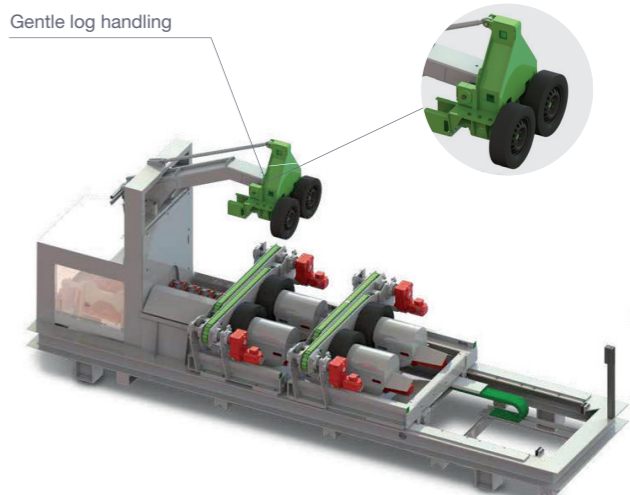

With the third movable overhead milling shaft, particularly long roots can be leveled. Thanks to the movable milling shaft units, special solutions with a reduction on both sides in the log infeed deck can also be implemented.

CONTACT US!

www.springer.eu

SPRINGER®

Springer Maschinenfabrik GmbH
Hans-Springer-Strasse 2
9360 Friesach
AUSTRIA

Tel.: +43 4268 2581 - 0
E-Mail: office@springer.eu
www.springer.eu

